

# Lubricator G 1/4, G 3/8

type	DO.11	DO.12	
item			
port size	G 1/4	G 3/8	
description proportional lubricator			
mounting vertically			
supply pressure Pe max. 16 bar, Pe max. 25 bar with metal bowl			
media and ambient temperature max. 60°C (oth. temperature ranges available upon request)			
bowl volume 40 cm³			
oil dosage rate when qv=1000 l/min 1-2 drips/min (determining factor)			
kind of oil CL 32 standardized to DIN 51517 - ISO VG 32			
fixing bracket			
weight 0,357 kg			



technical modifications keep in reserve!

**replacement parts**

no	description	material	order-no.
1	body	zinc - Z 410	---
2	O-ring 37 x 2	DF.11-8 NBR	1.1111.08.000
3	oil bowl	DO.11 polycarbonate	8.2311.24.000
4	dome assembly	DO.11 PA	9.9911.00.017/V
5	oil filler screw	L.11-8-1 St - NBR	7.2511.08.000

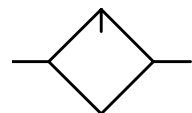

**series 1**

ordering information

DO. \*\* \*

type

port size  option

ordering example: DO.11 B

port size	
1	11 G 1/4
	12 G 3/8
options	
2	B bowl guard
	M metal bowl

**application information**

- oil fill in is possible under pressure

page: DO.11 (09/04)

**dimensions (mm)**

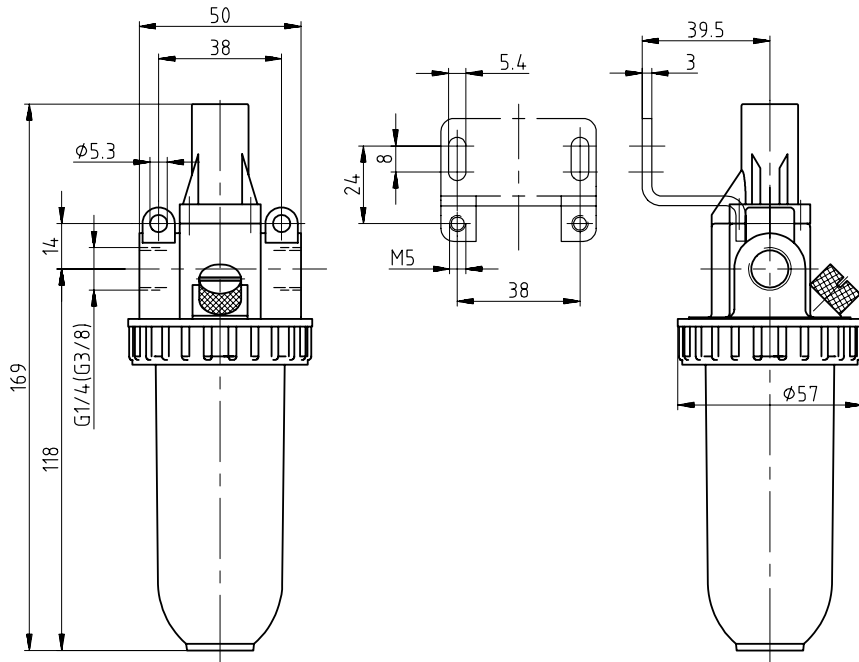

**flow characteristics**

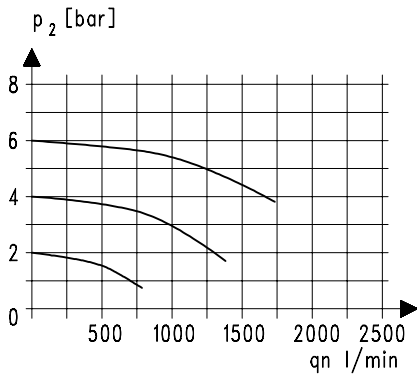

**lubricator operating limit**

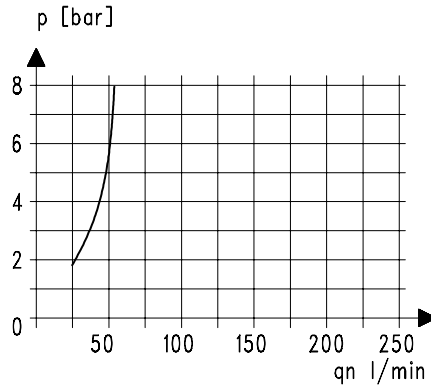

**accessories**

bowl guard

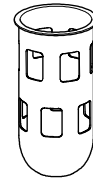

type: DF.11-35

mounting bracket

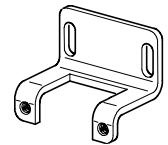

type: ZW.10

metal bowl

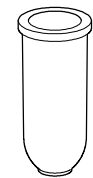

type: DO.11 M